

Cond 7310P

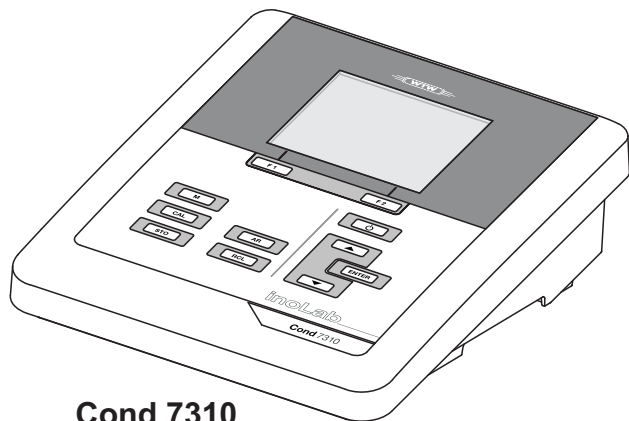

Cond 7310

Cond 7310

CONDUCTIVITY METER



a xylem brand



For the most recent version of the manual, please visit www.WTW.com.

Copyright

© 2017 Xylem Analytics Germany GmbH
Printed in Germany.

Cond 7310 - Contents

1	Overview	6
1.1	Cond 7310 meter	6
1.2	Cond 7310P meter	7
1.3	Sensors	7
2	Safety instructions	8
2.1	Safety information	8
2.1.1	Safety information in the operating manual	8
2.1.2	Safety signs on the meter	8
2.1.3	Further documents providing safety information	8
2.2	Safe operation	9
2.2.1	Authorized use	9
2.2.2	Requirements for safe operation	9
2.2.3	Unauthorized use	9
3	Commissioning	10
3.1	Scope of delivery	10
3.2	Power supply	10
3.3	Initial commissioning	10
3.3.1	Inserting the batteries	11
3.3.2	Connecting the power pack	12
3.3.3	Mounting the stand	12
4	Operation	13
4.1	General operating principles	13
4.1.1	Keypad	13
4.1.2	Display	14
4.1.3	Status information (meter)	14
4.1.4	Socket field	15
4.2	Switching on the meter	15
4.3	Switching off the meter	16
4.4	Navigation	16
4.4.1	Operating modes	16
4.4.2	Measured value display (measuring mode)	17
4.4.3	Menus and dialogs (setting mode)	17
4.4.4	Example 1 on navigation: Setting the language	18
4.4.5	Example 2 on navigation: Setting the date and time	20
5	Conductivity	22
5.1	Measuring	22

5.1.1	Measuring the conductivity	22
5.1.2	Measuring the temperature	24
5.2	Calibration	24
5.2.1	Why calibrate?	24
5.2.2	When to calibrate?	24
5.2.3	Determining the cell constant (calibration in control standard)	24
5.2.4	Calibration data	25
6	Settings	28
6.1	Measurement settings	28
6.1.1	Changing the settings for conductivity measuring cells	28
6.1.2	Calibration interval	30
6.1.3	Temperature compensation	31
6.1.4	Setting the TDS factor	31
6.2	Sensor-independent settings	32
6.2.1	<i>System</i>	32
6.2.2	<i>Data storage</i>	33
6.3	Reset	33
6.3.1	Resetting the measurement settings	33
6.3.2	Resetting the system settings	34
7	Data storage	35
7.1	Manual data storage	35
7.2	Automatic data storage at intervals	36
7.3	Measurement data storage	38
7.3.1	Displaying and editing the measurement data storage	38
7.3.2	Erasing the measurement data storage	40
7.3.3	Measurement dataset	40
7.3.4	Storage locations	40
8	Transmitting data (USB interface)	41
8.1	Options for data transmission	41
8.2	Connecting a PC	42
8.3	MultiLab Importer	42
9	Printer (only Cond 7310 P)	43
9.1	Commissioning / switching the printer on or off	43
9.2	Operation / printing	44
9.3	Printer settings	44
9.4	Maintenance	44
9.4.1	Changing the roll of paper	44
9.5	What to do if... / printer	45
10	Maintenance, cleaning, disposal	46
10.1	Maintenance	46

10.1.1	General maintenance activities	46
10.1.2	Replacing the batteries	46
10.2	Cleaning	47
10.3	Packing	47
10.4	Disposal	47
11	What to do if.....	48
11.1	Conductivity	48
11.2	General information	48
12	Technical data	50
12.1	Measuring ranges, resolution, accuracy	50
12.2	General data	52
13	Firmware update	54
14	Glossary	55
15	Index	57

1 Overview

1.1 Cond 7310 meter

The Cond 7310 compact precision conductivity meter enables you to perform conductivity measurements quickly and reliably.

The Cond 7310 provides the maximum degree of operating comfort, reliability and measuring certainty for all applications.

The USB interface can be used for data transmission to a PC and for software updates of the meter.

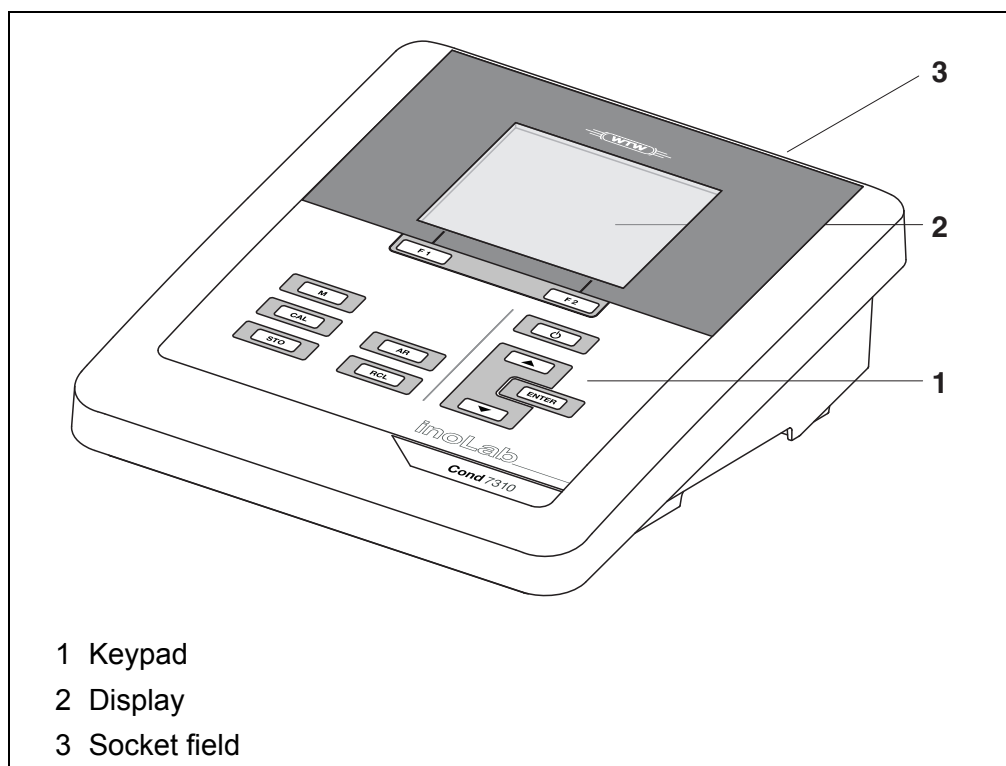

1.2 Cond 7310P meter

The integrated printer of the Cond 7310P enables to document measurements according to GLP requirements.



The information concerning the printer of the Cond 7310P is given in a separate chapter (see section 9 PRINTER (ONLY COND 7310 P), page 43).

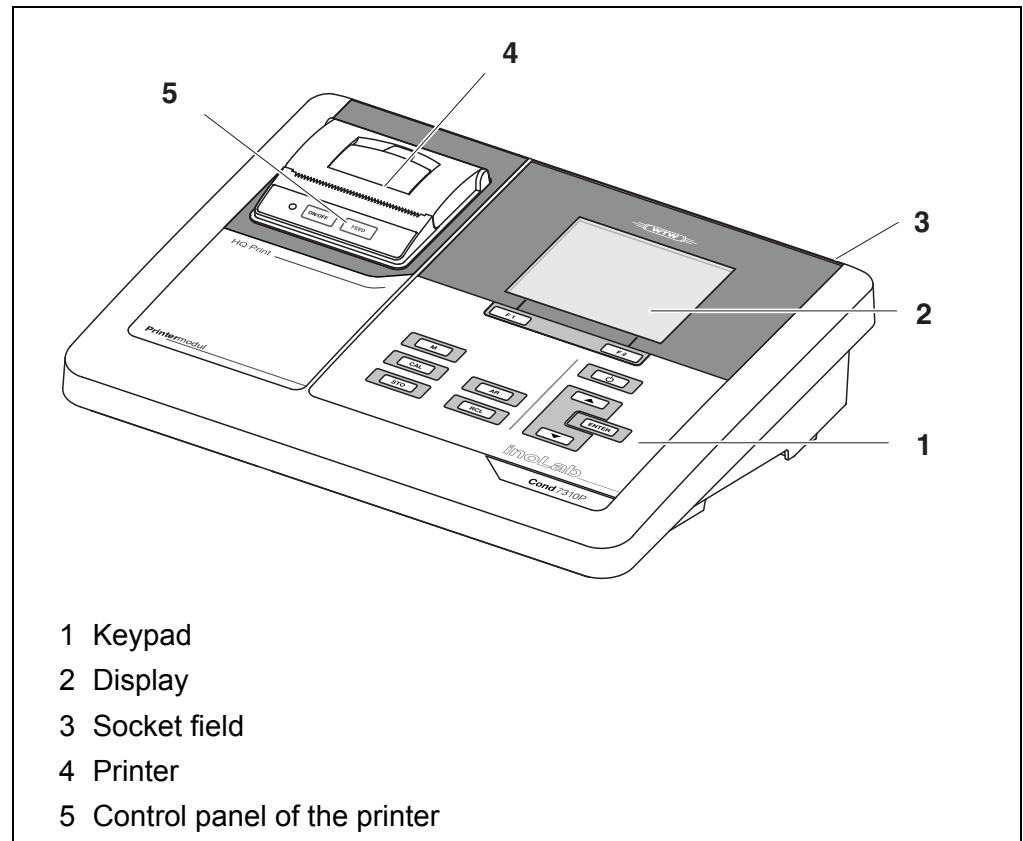

1.3 Sensors

A measuring system ready to measure consists of the Cond 7310 meter and a suitable sensor.

Suitable sensors are conductivity measuring cells.



Information on available sensors is given on the Internet.

2 Safety instructions

2.1 Safety information

2.1.1 Safety information in the operating manual

This operating manual provides important information on the safe operation of the meter. Read this operating manual thoroughly and make yourself familiar with the meter before putting it into operation or working with it. The operating manual must be kept in the vicinity of the meter so you can always find the information you need.

Important safety instructions are highlighted in this operating manual. They are indicated by the warning symbol (triangle) in the left column. The signal word (e.g. "Caution") indicates the level of danger:

**WARNING**

indicates a possibly dangerous situation that can lead to serious (irreversible) injury or death if the safety instruction is not followed.

**CAUTION**

indicates a possibly dangerous situation that can lead to slight (reversible) injury if the safety instruction is not followed.

NOTE

indicates a possibly dangerous situation where goods might be damaged if the actions mentioned are not taken.

2.1.2 Safety signs on the meter

Note all labels, information signs and safety symbols on the meter and in the battery compartment. A warning symbol (triangle) without text refers to safety information in this operating manual.

2.1.3 Further documents providing safety information

The following documents provide additional information, which you should observe for your safety when working with the measuring system:

- Operating manuals of sensors and other accessories
- Safety datasheets of calibration or maintenance accessories (such as buffer solutions, electrolyte solutions, etc.)

2.2 Safe operation

2.2.1 Authorized use

This meter is authorized exclusively for conductivity measurements in the laboratory.

Only the operation and running of the meter according to the instructions and technical specifications given in this operating manual is authorized (see section 12 TECHNICAL DATA, page 50).

Any other use is considered unauthorized.

2.2.2 Requirements for safe operation

Note the following points for safe operation:

- The meter may only be operated according to the authorized use specified above.
- The meter may only be supplied with power by the energy sources mentioned in this operating manual.
- The meter may only be operated under the environmental conditions mentioned in this operating manual.
- The meter may only be opened if this is explicitly described in this operating manual (example: Inserting the batteries).

2.2.3 Unauthorized use

The meter must not be put into operation if:

- it is visibly damaged (e.g. after being transported)
- it was stored under adverse conditions for a lengthy period of time (storing conditions, see section 12 TECHNICAL DATA, page 50).

3 Commissioning

3.1 Scope of delivery

- Conductivity meter Cond 7310
- 4 batteries 1.5 V Mignon type AA
- Power pack
- USB cable
- Stand
- Stand holder
- Comprehensive operating manual
- Short instructions
- CD-ROM with
 - USB drivers
 - comprehensive operating manual
 - software MultiLab Importer

3.2 Power supply

The Cond 7310 is supplied with power in the following ways:

- Mains operation with the supplied power pack.
- Battery operation (4 x alkaline manganese batteries, type AA)
- USB operation via a connected USB-B cable.

3.3 Initial commissioning

Perform the following activities:

- Insert the supplied batteries
- For mains operation: Connect the power pack
- If necessary, mount the stand
- Switch on the meter (see section 4.2 SWITCHING ON THE METER, page 15)
- Set the date and time (see section 4.4.5 EXAMPLE 2 ON NAVIGATION: SETTING THE DATE AND TIME, page 20)

3.3.1 Inserting the batteries



You can operate the meter either with normal batteries or with rechargeable batteries (Ni-MH). In order to charge the batteries, an external charging device is required.

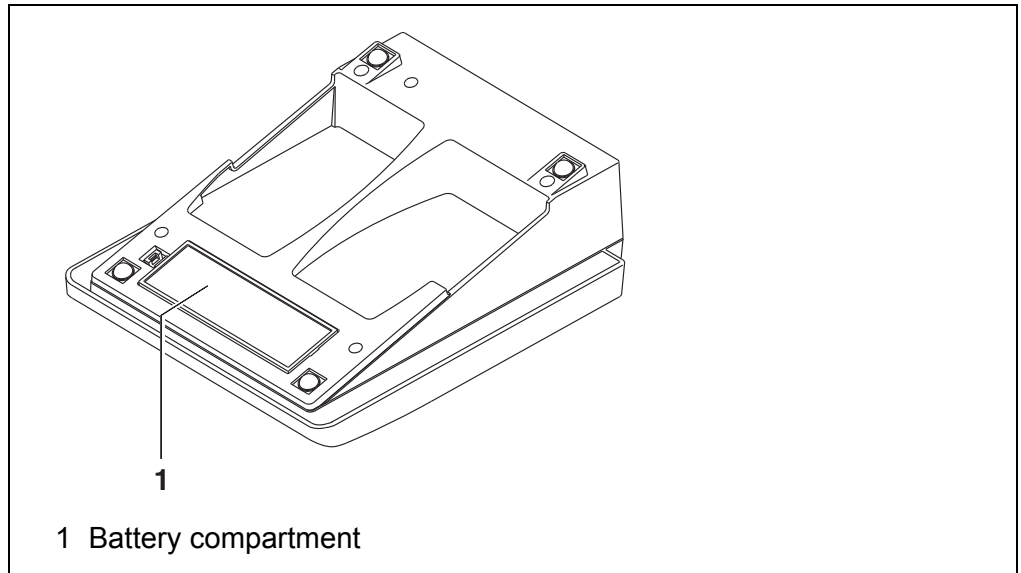

1. Open the battery compartment (1) on the underside of the meter.



CAUTION

**Make sure that the poles of the batteries are positioned correctly.
The ± signs on the batteries must correspond to the ± signs in the battery compartment.**

2. Place four batteries (type Mignon AA) in the battery compartment.
3. Close the battery compartment (1).
4. Set the date and time (see section 4.4.5 EXAMPLE 2 ON NAVIGATION: SETTING THE DATE AND TIME, page 20)

3.3.2 Connecting the power pack

**CAUTION**

The line voltage at the operating site must lie within the input voltage range of the original power pack (see section 12 TECHNICAL DATA, page 50).

**CAUTION**

Use original power packs only (see section 12 TECHNICAL DATA, page 50).

1. Connect the plug of the power pack to the socket for the power pack on the Cond 7310.
2. Connect the original power pack to an easily accessible power outlet.

3.3.3 Mounting the stand

The stand base can be mounted at the right side of the meter.

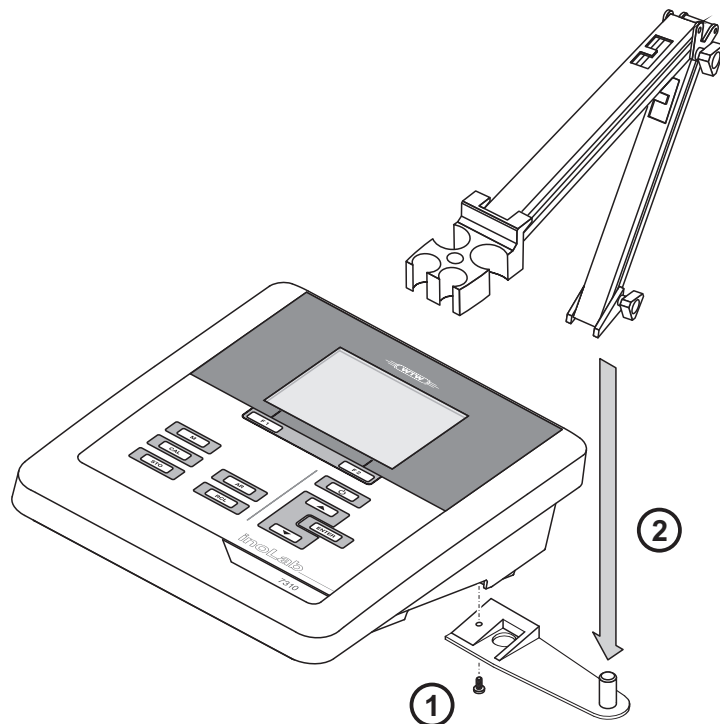









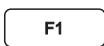
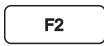

4 Operation

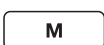
4.1 General operating principles

4.1.1 Keypad

In this operating manual, keys are indicated by brackets <.> .

The key symbol (e.g. <ENTER>) generally indicates a short keystroke (under 2 sec) in this operating manual. A long keystroke (approx. 2 sec) is indicated by the underscore behind the key symbol (e.g. <ENTER_>).

	<F1>: <F1_>: <F2>: <F2_>:	Softkeys providing situation dependent functions, e.g.: <F1>/[Menu]: Opens the menu for measurement settings <F1_>/[Menu]: Opens the menu for system settings
		
	<On/Off>:	Switches the meter on or off
	<M>:	Selects the measured parameter / Quits the settings
	<CAL>: <CAL_>:	Calls up the calibration procedure Displays the calibration data
	<STO>: <STO_>:	Saves a measured value manually Opens the menu for the automatic save function
	<RCL>: <RCL_>:	Displays the manually stored measured values Displays the automatically stored measured values
 	<▲><▼>: <▲_><▼_>:	Menu control, navigation Increments, decrements values Increments, decrements values continuously
	<ENTER>: <ENTER_>:	Opens the menu for measurement settings / confirms entries Opens the menu for system settings
	<AR>	Freezes the measured value (HOLD function) Switches the AutoRead measurement on or off

4.1.2 Display

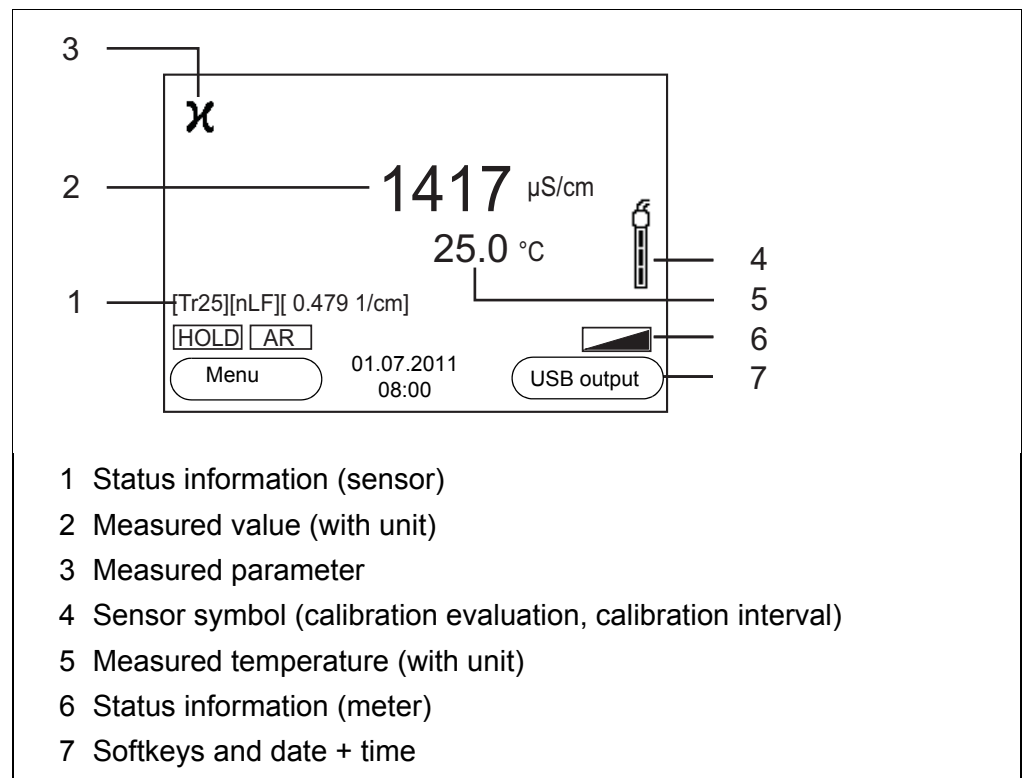

4.1.3 Status information (meter)

AR	Stability control (AutoRead) is active
HOLD	Measured value is frozen (<AR> key)
	Batteries almost empty

4.1.4 Socket field

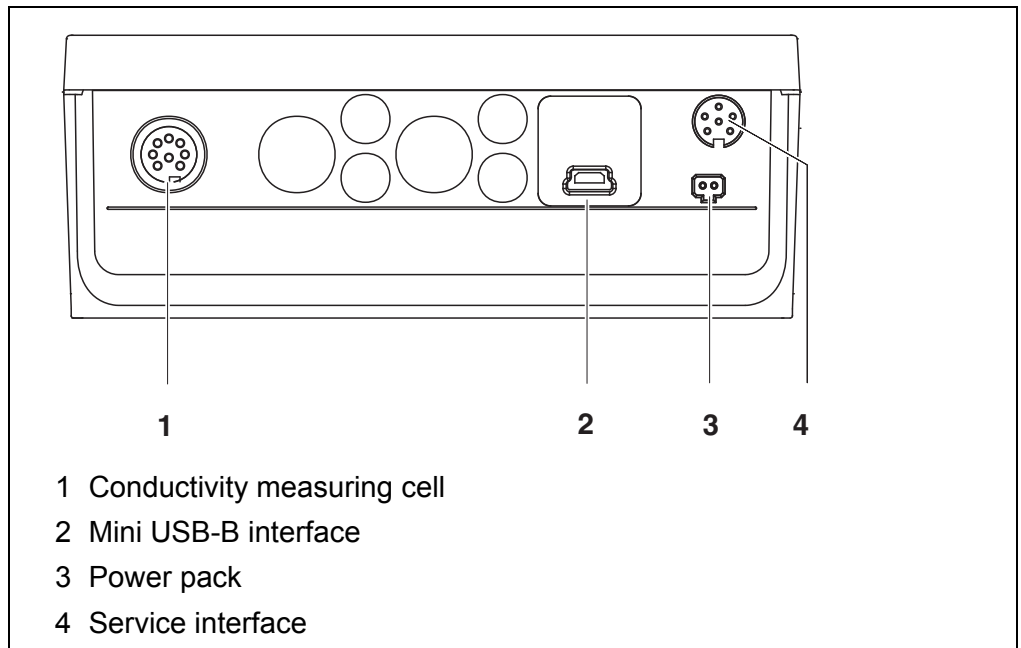

CAUTION

Only connect measuring cells to the meter that cannot return any voltages or currents that are not allowed (> SELV and > current circuit with current limiting).

Almost all customary measuring cells fulfill these conditions.

4.2 Switching on the meter

1. Switch the meter on with **<On/Off>**.
The meter performs a self-test.
The display shows the manufacturer's logo while the self-test is being performed.
The measured value display appears.

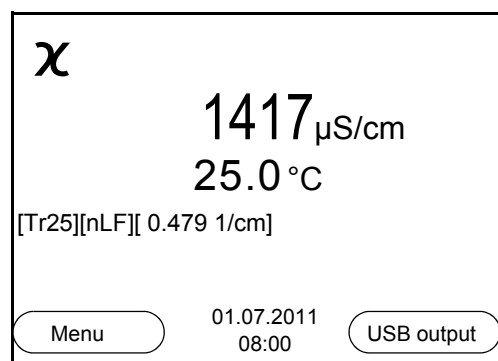

4.3 Switching off the meter

1. Switch the printer off with **<On/Off>**.

Automatic switch-off

The instrument has an automatic switch-off function in order to save the batteries (see section 6.2.1 SYSTEM, page 32). The automatic switchoff function switches off the meter if no key is pressed for an adjustable period.

The automatic switchoff function is not active

- if the communication cable is connected
- if the *Automatic data storage* function is active, or with *automatic data transmission*
- if the power pack is connected

Display illumination

The meter automatically switches off the display illumination if no key is pressed for 30 seconds. The illumination is switched on with the next keystroke again.

You can also generally switch the display illumination on or off (see section 6.2.1 SYSTEM, page 32).

4.4 Navigation

The principles of navigation in menus and dialogs are explained in the following sections.

4.4.1 Operating modes

The meter has the following operating modes:

Operating mode	Description
Measuring	The measurement data of the connected sensor are shown in the measured value display
Calibration	The course of a calibration with calibration information, functions and settings is displayed
Storage in memory	The meter stores measuring data automatically or manually
Transmitting data	The meter transmits measuring data and calibration records to a USB-B interface automatically or manually.
Setting	The system menu or a sensor menu with submenus, settings and functions is displayed

Only those displays and functions are available in the active operating mode that are currently being required.

4.4.2 Measured value display (measuring mode)

In the measured value display, open the setting menus with the **<F1>** softkey. The current functions of the softkeys are shown on the display.

- Use **<F1>/[Menu]** (short pressure) to open the menu for calibration and measurement settings for the displayed measured parameter.
- Use **<F1_>/[Menu]** (long pressure (approx. 2 s)) to open the *Storage & config* menu with the sensor-independent settings.

Use the keys of the keypad to carry out further functions such as storage or calibration (see section 4.1.1 KEYPAD, page 13). These functions are not available in other operating situations.

4.4.3 Menus and dialogs (setting mode)

The menus for settings and dialogs in procedures contain further subelements.

- To select a subelement, use the **<▲><▼>** keys. The current selection is displayed with a frame.
- To make further settings, switch to the next higher menu level with **<F1>[Back]**.
- Use **<M>** to return to the measured value display.

Elements in menus and dialogs

- Submenus

The name of the submenu is displayed at the upper edge of the frame. Submenus are opened by confirming with **<ENTER>**. Example:

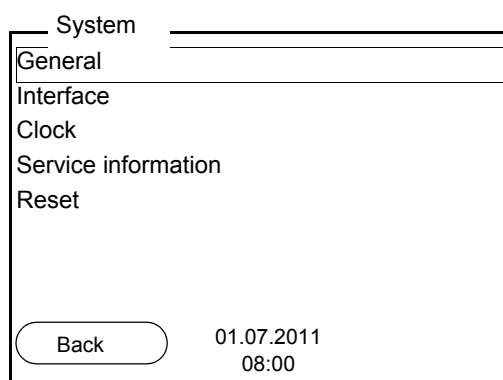

- Settings

Settings are indicated by a colon. The current setting is displayed on the right-hand side. The setting mode is opened with **<ENTER>**. Subsequently, the setting can be changed with **<▲><▼>** and **<ENTER>**. Example:

General	
Language:	Deutsch
Beep:	Off
Illumination:	On
Contrast:	48 %
Switchoff time:	30 min
<input type="button" value="Back"/>	
01.07.2011 08:00	

- **Functions**

Functions are designated by the name of the function. They are immediately carried out by confirming with **<ENTER>**.

Example: Display the *Calibration record* function.

χ	
Calibration record	
Calibration data storage	
Calibration interval:	150 d
<input type="button" value="Back"/>	
01.07.2011 08:00	

- **Messages**

Information is marked by the **i** symbol. It cannot be selected. Example:

χ	
Measuring cell	
Temp. comp. (TC)	
TDS factor	1.00
Stability control	On
Temperature unit	°C
i χ = 1413 μS/cm	
<input type="button" value="Back"/>	
01.07.2011 08:00	

4.4.4 Example 1 on navigation: Setting the language

1. Press the **<On/Off>** key.
The measured value display appears.
The instrument is in the measuring mode.

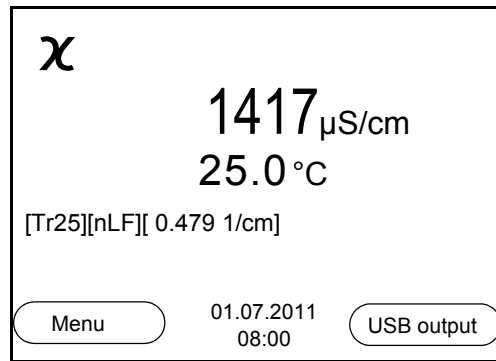

- Using **<F1_>/[Menu]**, open the *Storage & config* menu. The instrument is in the setting mode.

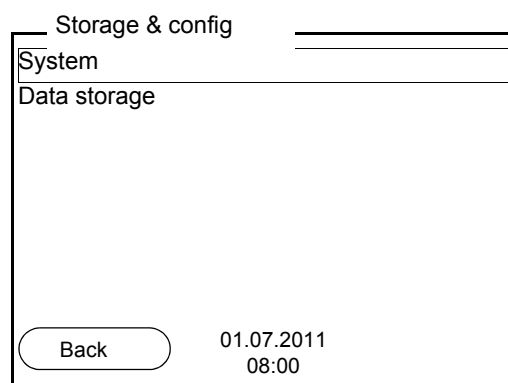

- Select the *System* submenu with **<▲><▼>**. The current selection is displayed with a frame.
- Open the *System* submenu with **<ENTER>**.

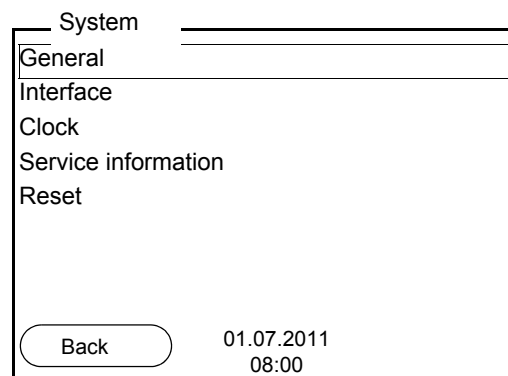

- Select the *General* submenu with **<▲><▼>**. The current selection is displayed with a frame.
- Open the *General* submenu with **<ENTER>**.

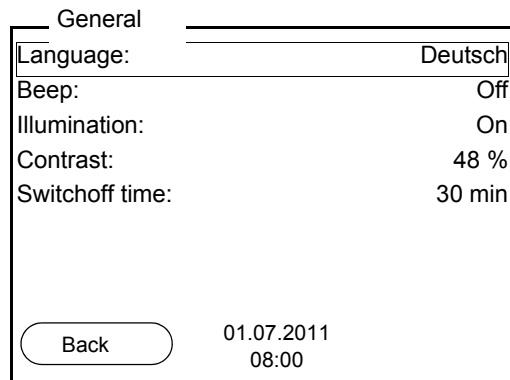

7. Open the setting mode for the *Language* with **<ENTER>**.

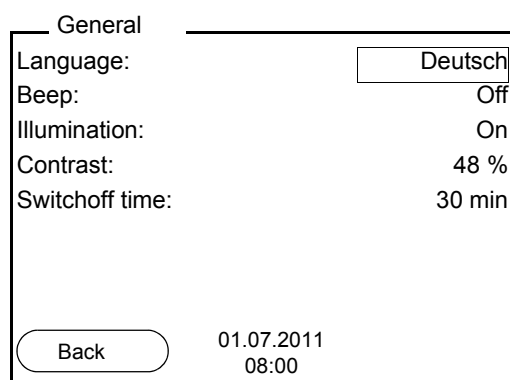

8. Select the required language with **<▲><▼>**.
9. Confirm the setting with **<ENTER>**.
The meter switches to the measuring mode.
The selected language is active.

4.4.5 Example 2 on navigation: Setting the date and time

The measuring instrument has a clock with a date function. The date and time are indicated in the status line of the measured value display. When storing measured values and calibrating, the current date and time are automatically stored as well.

The correct setting of the date and time and date format is important for the following functions and displays:

- Current date and time
- Calibration date
- Identification of stored measured values.

Therefore, check the time at regular intervals.



After a fall of the supply voltage (empty batteries), the date and time are reset.

Setting the date, time and date format

The date format can be switched from the display of day, month, year (*dd.mm.yyyy*) to the display of month, day, year (*mm/dd/yyyy* or *mm.dd.yyyy*).

1. In the measured value display:
Using **<F1_>/[Menu]**, open the *Storage & config* menu.
The instrument is in the setting mode.
2. Select and confirm the *System / Clock* menu with **<▲><▼>** and **<ENTER>**.
The setting menu for the date and time opens up.
3. Select and confirm the *Time* menu with **<▲><▼>** and **<ENTER>**.
The hours are highlighted.

Clock	
Date format:	dd.mm.yyyy
Date:	01.07.2011
Time:	08:00:25
<div style="display: flex; justify-content: space-between; align-items: center;"> Back 01.07.2011 08:00 </div>	

4. Change and confirm the setting with **<▲><▼>** and **<ENTER>**.
The minutes are highlighted.
5. Change and confirm the setting with **<▲><▼>** and **<ENTER>**.
The seconds are highlighted.
6. Change and confirm the setting with **<▲><▼>** and **<ENTER>**.
The time is set.
7. If necessary, set the *Date* and *Date format*. The setting is made similarly to that of the time.
8. To make further settings, switch to the next higher menu level with **[Back]<F1>**.
or
Switch to the measured value display with **<M>**.
The instrument is in the measuring mode.

5 Conductivity

5.1 Measuring

5.1.1 Measuring the conductivity

NOTE

When connecting a grounded PC, measurements cannot be performed in grounded media as the values would be incorrect. The USB interface is not galvanically isolated.

1. Connect the conductivity measuring cell to the measuring instrument. The conductivity measuring screen is displayed.
2. If necessary, select the measured parameter with **<M>**.
3. Check the *Measuring cell* settings and cell constant for the connected conductivity measuring cell. If necessary, correct the settings.



The selection of the measuring cell and the setting of the cell constant is done in the measurement settings menu for conductivity (see section 6.1.1 CHANGING THE SETTINGS FOR CONDUCTIVITY MEASURING CELLS, page 28). The cell constant to be set must either be taken from the operating manual of the measuring cell or is printed on the measuring cell.

4. Immerse the conductivity measuring cell in the test sample.

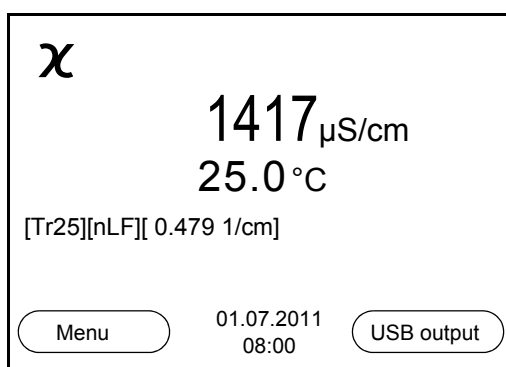

5. If necessary, select the measured parameter with **<M>**.
 - Conductivity [$\mu\text{S}/\text{cm}$] / [mS/cm]
 - Resistivity [$\Omega\cdot\text{cm}$] / [$\text{k}\Omega\cdot\text{cm}$] / [$\text{M}\Omega\cdot\text{cm}$]
 - Salinity SaL []
 - Total dissolved solids TDS [mg/l] / [g/l]



The factor to calculate the total dissolved solids is set to 1.00 in the factory. You can adjust this factor to meet your requirements in the range 0.40 ... 1.00. The factor is set in the *Measurement* menu for the parameter, TDS.

Stability control (AutoRead) & HOLD function

The stability control function (*AutoRead*) continually checks the stability of the measurement signal. The stability has a considerable impact on the reproducibility of measured values.

The display of the measured parameter flashes.

- as soon as the measured value is outside the stability range.
- when the automatic *Stability control* is switched off.

You can activate or switch off the automatic *Stability control* function (see section 6.1.1 CHANGING THE SETTINGS FOR CONDUCTIVITY MEASURING CELLS, page 28).

1. Freeze the measured value with **<AR>**.
The [HOLD] status indicator is displayed.
The HOLD function is active.



You can terminate the *Stability control* function and the HOLD function with **<AR>** or **<M>** at any time.

2. Using **<ENTER>**, activate the *Stability control* function manually. The [AR] status indicator appears while the measured value is assessed as not stable. A progress bar is displayed and the display of the measured parameter flashes. The [HOLD][AR] status indicator appears as soon as a stable measured value is recognized. The progress bar disappears and the display of the measured parameter stops flashing. The current measurement data is output to the interface. Measurement data meeting the stability control criterion is marked by AR.



You can prematurely terminate the *Stability control* function manually with **<ENTER>** at any time. If the *Stability control* function is prematurely terminated, the current measurement data are output to the interface without the AutoRead info.

3. Using **<ENTER>**, start a further measurement with stability control.
or
Release the frozen measured value again with **<AR>** or **<M>**.
The [AR] status display disappears. The display switches back to the previous indication.

Criteria for a stable measured value

The *Stability control* function checks whether the measured values are stable within the monitored time interval.

Measured parameter	Time interval	Stability in the time interval
Conductivity χ	10 seconds	Δ : Better than 1.0% of measured value
Temperature	15 seconds	Δ : Better than 0.5 °C

The minimum duration until a measured value is assessed as stable is the monitored time interval. The actual duration is mostly longer.

5.1.2 Measuring the temperature

For reproducible conductivity measurements, it is essential to measure the temperature of the test sample.

The temperature is automatically measured by the temperature sensor (NTC30 or Pt1000) integrated in the sensor.



The TetraCon 325, KLE 325, LR 325/01 and LR 325/001 conductivity sensors have an integrated temperature sensor.

5.2 Calibration**5.2.1 Why calibrate?**

Aging slightly changes the cell constant, e. g. due to coatings. As a result, an inexact measured value is displayed. The original characteristics of the cell can often be restored by cleaning the cell. Calibration determines the current value of the cell constant and stores this value in the meter.

Thus, you should calibrate at regular intervals (we recommend: every 6 months).

5.2.2 When to calibrate?

- After connecting a sensor
- Routinely within the framework of the company quality assurance
- When the cleaning interval has expired

5.2.3 Determining the cell constant (calibration in control standard)

You can determine the actual cell constant of the conductivity measuring cell by calibrating with the control standard in the following ranges:

- 0.450 ... 0.500 cm^{-1}
(e.g. TetraCon 325 with a nominal cell constant of 0.475 $^{-1}$)

- 0.800 ... 0.880 cm⁻¹
(e.g. KLE 325 with a nominal cell constant of 0.840⁻¹)

The cell constant is determined in the control standard, 0.01 mol/l KCl. Cell constants outside the ranges quoted above cannot be calibrated.

In the delivery condition, the calibrated cell constant of the meter is set to 0.475 cm⁻¹ (conductivity measuring cell, TetraCon 325).

For this calibration procedure, the *Measuring cell* setting must be set to cal in the *Measurement* menu. Proceed as follows to determine the cell constant:

1. Connect the conductivity measuring cell to the measuring instrument.
2. In the measured value display, select the conductivity parameter with **<M>**.
3. Start the calibration with **<CAL>**.
The cell constant that was calibrated last is displayed.

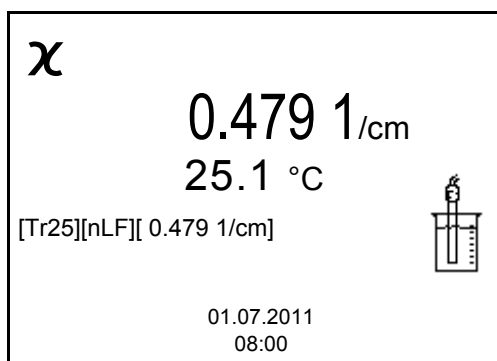

4. Immerse the conductivity measuring cell in the control standard solution, 0.01 mol/l KCl.
5. Start the measurement with **<ENTER>**.
The [AR] status indicator is displayed. A progress bar is displayed and the display of the measured parameter flashes.
6. Wait for the end of the measurement with stability control or accept the calibration value with **<ENTER>**.
The calibration record is displayed and output to the interface.
7. Using **<F1>** / [Continue] or **<ENTER>**, switch to the measured value display.

5.2.4 Calibration data



The calibration record is automatically transmitted to the interface after calibrating.

Displaying the calibration data

The calibration record of the last calibration is to be found under the menu item, **<F1>** / [Menu] / *Calibration* / *Calibration record*. To open it, press the **<CAL_>** key in the measured value display.

Subsequently, you can transmit the displayed calibration data to the interface, e. g. to a PC, with **<F2>**[USB output].

Displaying the calibration data storage

The calibration records of the last calibrations (up to 10) are available in the menu, **<F1>**/[Menu] / Calibration / Calibration data storage and in the menu, **<F1_>**/[Menu] / Storage & config/Data storage / Calibration data storage.

Menu item	Setting/function	Description
Calibration / Calibration data storage /Display or Data storage / Calibration data storage /Display	-	Displays the calibration record. Further options: <ul style="list-style-type: none"> ● Scroll through the calibration records with <▲><▼>. ● Output the displayed calibration record to the interface with <F2>/[USB output]. ● Quit the display with <F1>/[Back] or <ENTER>. ● Switch directly to the measured value display with <M>.
Calibration / Calibration data storage / Output to USB or Data storage / Calibration data storage /Output to USB	-	Outputs the calibration records to the interface.

Calibration evaluation

After the calibration, the meter automatically evaluates the current status of the calibration. The evaluation appears on the display and in the calibration record.

Display	Calibration record	Cell constant [cm ⁻¹]
	+++	within the ranges 0.450 ... 0.500 cm ⁻¹ or 0.800 ... 0.880 cm ⁻¹
Error Error elimination (see section 11 WHAT TO DO IF..., page 48)	Error	outside the ranges 0.450 ... 0.500 cm ⁻¹ or 0.800 ... 0.880 cm ⁻¹

**Calibration record
(example)**

inoLab Cond 7310
Ser. no. 11292113

CALIBRATION Cond
01.07.2011 16:13:33

Ser. no. 10501234
Cell constant 0.479 1/cm 25.0 °C
Sensor +++

6 Settings

6.1 Measurement settings

6.1.1 Changing the settings for conductivity measuring cells

The settings are made in the *Measurement* menu for the measured parameter, conductivity. To open the settings, display the required parameter in the measured value display and press the **<F1>/[menu]** or **<ENTER>** key. After completing the settings, switch to the measured value display with **<M>**.

Default settings are printed in **bold**.

Menu item	Possible setting	Description
<i>Calibration / Calibration record</i>	-	Displays the calibration record of the last calibration.
<i>Calibration / Calibration data storage / Display</i>	-	Displays the calibration record. Further options: <ul style="list-style-type: none"> ● Scroll through the calibration records with <▲><▼>. ● Output the displayed calibration record to the interface with <F2>/[USB output]. ● Output all calibration records to the interface with <F2__>/[USB output]. ● Quit the display with <F1>/[Back] or <ENTER>. ● Switch directly to the measured value display with <M>.
<i>Calibration / Calibration data storage / Output to USB</i>	-	Outputs the calibration records to the interface.
<i>Calibration / Serial number (sensor)</i>	-	Entry of the serial number of the connected sensor. The serial number is output in the calibration record. <ul style="list-style-type: none"> ● Change the contents of the highlighted position with <▲><▼>. ● Go to the next position with <F2>/[▶]. ● When the serial number has been completely entered, confirm with <ENTER>.

Menu item	Possible setting	Description
Calibration / Calibration interval	1 ... 150 ... 999 d	<i>Calibration interval</i> for the measuring cell (in days). The meter reminds you to calibrate regularly by the flashing sensor symbol in the measuring screen.
Measurement / Measuring cell / Type	Cal LR325/01 LR325/001 man	<i>Measuring cell used</i> Measuring cells whose cell constant is determined by calibration in the KCL control standard solution. Calibration ranges: 0.450 ... 0.500 cm ⁻¹ and 0.800 ... 0.880 cm ⁻¹ The currently valid cell constant is displayed in the status line. LR 325/01 measuring cell, nominal cell constant 0.100 cm ⁻¹ . The cell constant can be adjusted in the range 0.090 ... 0.110 cm ⁻¹ . LR 325/001 measuring cell, nominal cell constant 0.010 cm ⁻¹ . The cell constant is permanently set. Any measuring cells with freely adjustable cell constants in the range 0.250 ... 25.000 cm ⁻¹ .
Measurement / Measuring cell / Cell const. man	0.250 ... 0.475 25.000 cm ⁻¹	Display and setting option of the cell constant of any measuring cells (man).
Measurement / Measuring cell / Cell const. LR325/01	0.090 ... 0.100 ... 0.110 cm ⁻¹	Display and setting option of the cell constant of the LR 325/01 measuring cell.
Measurement / Temp. comp. (TC) /Method	nLF Lin Off	Procedure for temperature compensation (see section 6.1.3 TEMPERATURE COMPENSATION, page 31). This setting is only available for the measured parameters, χ and ρ .
Measurement / Temp. comp. (TC) /Linear coeff.	0.000 ... 2.000 ... 10.000 %/K	Coefficient of the linear temperature compensation. This setting is only available when the linear temperature compensation is set.

Menu item	Possible setting	Description
<i>Measurement / Temp. comp. (TC) / Reference temp.</i>	20 °C 25 °C	Reference temperature This setting is only available for the measured parameters, χ and ρ .
<i>Measurement / TDS factor</i>	0.40 ... 1.00	Factor for TDS value
<i>Measurement / Stability control</i>	On Off	Switches on or off the automatic stability control during measurement (see section Stability control (AutoRead) & HOLD function, page 23)
<i>Measurement / Temperature unit</i>	°C °F	Temperature unit, degrees Celsius or degrees Fahrenheit. All temperature values are displayed with the selected unit.
<i>Reset</i>	-	Resets all sensor settings to the delivery condition (see section 6.3.1 RESETTING THE MEASUREMENT SETTINGS, page 33).

6.1.2 Calibration interval

The calibration evaluation is displayed as a sensor symbol.

The sensor symbol flashes after the adjusted calibration interval has expired. It is still possible to measure.



To ensure the high measuring accuracy of the meter, calibrate after the calibration interval has expired.

Setting the calibration interval

The calibration interval is set to 150 days in the factory. You can change the interval (1 ... 999 days):

1. Open the menu for measurement settings with [Menu]<F1>.
2. In the *Calibration / Calibration interval* menu, set the calibration interval with <▲><▼>.
3. Confirm the setting with <ENTER>.
4. Quit the menu with <M>.

6.1.3 Temperature compensation

The calculation of the temperature compensation is based on the preset reference temperature, 20 °C or 25 °C. It appears on the display as Tr20 or Tr25.

You can select one of the following temperature compensation methods:

- **Nonlinear temperature compensation (nLF)** according to EN 27 888
- **Linear temperature compensation (lin)** with adjustable coefficient in the range 0.000 ... 10.000 %/K
- **No temperature compensation (off)**



The reference temperature and temperature compensation are set in the *Measurement* menu for the parameter, conductivity (see section 6.1.1 CHANGING THE SETTINGS FOR CONDUCTIVITY MEASURING CELLS, page 28).

Application tips

Set the temperature compensation suitable for your test sample:

Test sample	Temperature compensation	Display
Natural water (ground water, surface water, drinking water)	<i>nLF</i> according to EN 27 888	<i>nLF</i>
Ultrapure water	<i>nLF</i> according to EN 27 888	<i>nLF</i>
Other aqueous solutions	<i>lin</i> Set linear temperature coefficient 0.000 ... 10.000 %/K	<i>lin</i>
Salinity (seawater)	Automatic <i>nLF</i> according to IOT (International Oceanographic Tables)	<i>Sal, nLF</i>

6.1.4 Setting the TDS factor

The factor to calculate the total dissolved solids is set to 1.00 in the delivery condition.

You can adjust this factor to meet your requirements in the range 0.40 ... 1.00.

The factor is set in the menu for the parameter TDS (*Measurement / TDS factor*).

6.2 Sensor-independent settings

6.2.1 System

To open the *Storage & config* menu, press the <F1_>[Menu] key in the measured value display. After completing the settings, switch to the measured value display with <M>.

Default settings are printed in **bold**.

Menu item	Possible setting	Description
<i>System / General / Language</i>	<i>Deutsch</i> English <i>(further)</i>	Selects the menu language
<i>System / General / Beep</i>	On <i>Off</i>	Switches on/off the beep on keystroke
<i>System / General / Illumination</i>	Auto <i>On</i> <i>Off</i>	Switches the display illumination on/off
<i>System / General / Contrast</i>	<i>0 ...</i> 50 <i>... 100</i> %	Changes the display contrast
<i>System / General / Switchoff time</i>	<i>10 min ...</i> 1h <i>... 24 h</i>	Adjusts the switch-off time
<i>System / Interface / Baud rate</i>	<i>1200, 2400,</i> 4800 , <i>9600,</i> <i>19200</i>	Baud rate of the data interface
<i>System / Interface / Output format</i>	ASCII <i>CSV</i>	Output format for data transmission For details, see section 8 TRANSMITTING DATA (USB INTERFACE), page 41
<i>System / Interface / Decimal separator</i>	Dot (xx.x) <i>Comma</i> <i>(xx,x)</i>	Decimal separator
<i>System / Interface / Output header</i>		Output of a header for <i>Output format: CSV</i>
<i>System / Printer</i>		Settings for the integrated printer of the Cond 7310P. For details, see section 9 PRINTER (ONLY COND 7310 P), page 43

Menu item	Possible setting	Description
<i>System /Clock</i>	<i>Time</i> <i>Date</i> <i>Date format</i>	Settings of time and date. For details, see section 4.4.5 EXAMPLE 2 ON NAVIGATION: SETTING THE DATE AND TIME, page 20
<i>System /Service information</i>		Hardware version and software version of the meter are displayed.
<i>System /Reset</i>	-	Resets the system settings to the default values. For details, see section 6.3.2 RESETTING THE SYSTEM SETTINGS, page 34

6.2.2 Data storage

This menu contains all functions to display, edit and erase stored measured values and calibration records (see section 7 DATA STORAGE, page 35).

6.3 Reset

You can reset (initialize) all sensor settings and sensor-independent settings separately from each other.

6.3.1 Resetting the measurement settings



The calibration data are reset to the default settings together with the measuring parameters. Recalibrate after performing a reset.

The following settings for conductivity measurements are reset to the default settings with the *Reset* function:

Setting	Default settings
<i>Cal. interval</i>	150 d
<i>Measured parameter</i>	χ
<i>Cell constant (C)</i> <i>(calibrated)</i>	0.475 cm ⁻¹ or 0.840 cm ⁻¹ (nominal cell constant of the conductivity measuring cell last calibrated)
<i>Cell constant (C)</i> <i>(set)</i>	0.475 cm ⁻¹
<i>Temperature compensation</i>	nLF

Setting	Default settings
<i>Reference temperature</i>	25 °C
<i>Temperature coefficient (TC) of the linear temperature compensation</i>	2.000 %/K
<i>TDS factor</i>	1,00
<i>Stability control</i>	On
<i>Temperature unit</i>	°C

The sensor settings are reset under the *Reset* menu item in the menu for calibration and measurement settings. To open it, press the <F1>/[Menu] or <ENTER> key in the measured value display.

6.3.2 Resetting the system settings

The following system settings can be reset to the default condition:

Setting	Default settings
<i>Language</i>	English
<i>Beep</i>	On
<i>Baud rate</i>	4800 Baud
<i>Output format</i>	ASCII
<i>Contrast</i>	50 %
<i>Illumination</i>	On
<i>Switchoff time</i>	1 h

The system settings are reset in the menu, *Storage & config / System / Reset*. To open the *Storage & config* menu, press the <F1_>/[Menu] key in the measured value display.

7 Data storage

You can transmit measured values (datasets) to the data storage:

- Manual storage (see section 7.1 MANUAL DATA STORAGE, page 35)
- Automatic storage at intervals (see section 7.2 AUTOMATIC DATA STORAGE AT INTERVALS, page 36)

Each storage process transmits the current dataset to the interface at the same time.

7.1 Manual data storage

You can transmit a measurement dataset to the data storage as follows. The dataset is at the same time output to the interface:

1. Press the **<STO>** key shortly.
The menu for manual storage appears.

Manual data storage 4 From

01.07.2011 11:24:16
 χ 1415 μ S/cm 25.1 °C AR +++
 C = 0.479 1/cm, Tref 25, nLF

ID number: 1

Continue

Back 01.07.2011
08:00

2. If necessary, change and confirm the ID number (1 ... 10000) with **<▲>****<▼>** and **<ENTER>**.
The dataset is stored. The meter switches to the measured value display.

If the data storage is full

The following window appears if all 200 storage locations are occupied:

Warning

Data storage full. Erase?

Yes

No

Back 01.07.2011
08:00

You have the following options:

- To erase the entire data storage, confirm *Yes*.
- To cancel the storage process and switch to the measured value display, confirm *No*. Then you can e.g. transmit the stored data to a PC (see section 7.3.1 DISPLAYING AND EDITING THE MEASUREMENT DATA STORAGE, page 38) and subsequently erase the storage (see section 7.3.2 ERASING THE MEASUREMENT DATA STORAGE, page 40).

7.2 Automatic data storage at intervals

The storage interval (*Interval*) determines the time interval between automatic storage processes. Each storage process transmits the current dataset to the interface at the same time.

Configuring the automatic storage function

1. Press the **<STO_>** key.
The menu for automatic storage appears.

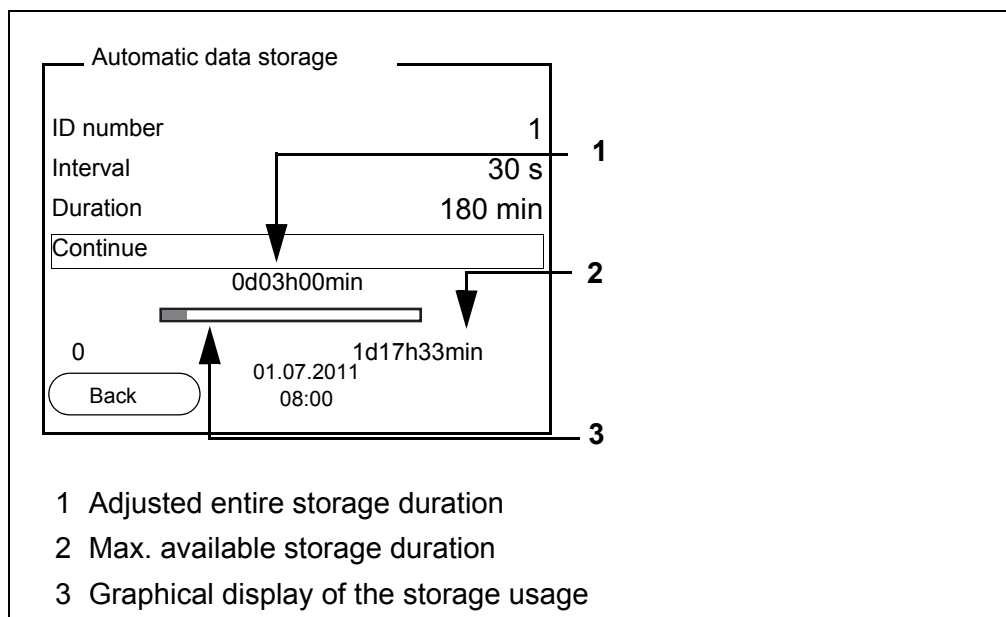

Settings You can configure the automatic storage function with the following settings:

Menu item	Possible setting	Description
<i>ID number</i>	1 ... 10000	ID number for the dataset series.
<i>Interval</i>	1 s, 5 s, 10 s, 30 s, 1 min, 5 min, 10 min, 15 min, 30 min, 60 min	Storage interval. The lower limit of the storage interval can be restricted by the number of free storage locations. The upper limit is restricted by the storage duration.
<i>Duration</i>	1 min ... x min	Storage duration. Specifies after which time the automatic storage should be terminated. The lower limit of the storage duration is restricted by the storage interval. The upper limit is restricted by the number of free storage locations.

Starting the automatic storage function

To start the automatic storage function, select *Continue* with \blacktriangle \blacktriangledown and confirm with **<ENTER>**. The meter switches to the measured value display.

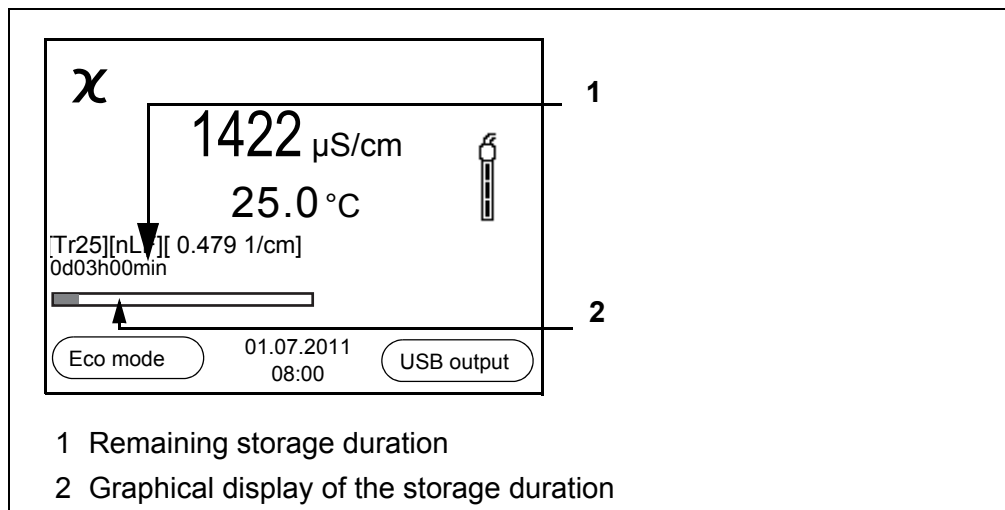

The active automatic storage function can be recognized by the progress bar in the status line. The progress bar indicates the remaining storage duration.



If the automatic storage function is activated, only the following keys are active: Softkeys, **<M>**, **<STO_>** and **<On/Off>**. The other keys and the automatic switch-off function are deactivated.

Energy saving mode [Eco mode]

If the automatic storing function is active, the meter provides an energy saving mode [Eco mode] to avoid unnecessary energy consumption. The energy

saving mode switches off functions of the meter that are not required for the automatic storage of measurement data (such as the display). By pressing any key the energy saving mode is switched off again.

Terminating the automatic storage function prematurely

Proceed as follows to switch off the automatic storage function before the adjusted storage duration has expired:

1. Press the **<STO_>** key.
The following window appears.

The image shows a rectangular dialog box with a thin border. At the top left, the word "Warning" is displayed. Below it, the text "Stop automatic storage?" is centered. Underneath, the word "Yes" is on the left and "No" is on the right, with a horizontal line below them. At the bottom left, there is a rounded rectangular button labeled "Back". To the right of the button, the date and time "01.07.2011 08:00" are displayed.

2. Using **<▲><▼>**, select Yes and confirm with **<ENTER>**.
The meter switches to the measured value display.
The automatic storage function is terminated.

7.3 Measurement data storage

7.3.1 Displaying and editing the measurement data storage

The contents of the manual or automatic measurement data storage can be shown on the display and output to the interface.

Each of the measurement data storages has a function to erase the entire contents.

Editing the data storage

The storage is edited in the menu, *Storage & config / Data storage*. To open the *Storage & config* menu, press the **<F1_>**[Menu] key in the measured value display. Open the manual or automatic storage directly with the **<RCL>** or **<RCL_>** key.



The settings are explained here using the manual storage as an example. The same settings and functions are available for the automatic storage.

Settings	Menu item	Set- ting/ func- tion	Description
	<i>Data storage / Manual data storage / Display</i>	-	Displays all measurement datasets page by page. Further options: <ul style="list-style-type: none"> ● Scroll through the datasets with <▲><▼>. ● Output the displayed dataset to the interface with <F2>/[USB output]. ● Quit the display with <F1>/[Back].
	<i>Data storage / Manual data storage / Erase</i>	-	Erases the entire manual measurement data storage. All calibration data remain stored when this action is performed.
	<i>Data storage / Manual data storage / Output to USB</i>	-	Outputs all stored measurement data to the interface.

Display presentation of a dataset

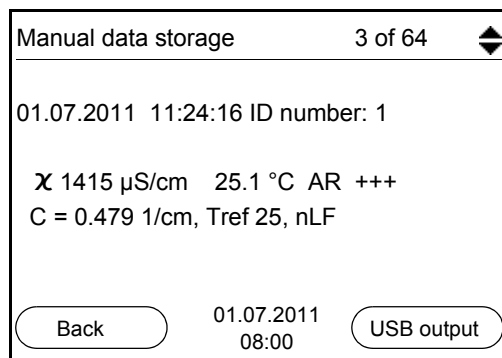

Representation of a dataset (USB output)

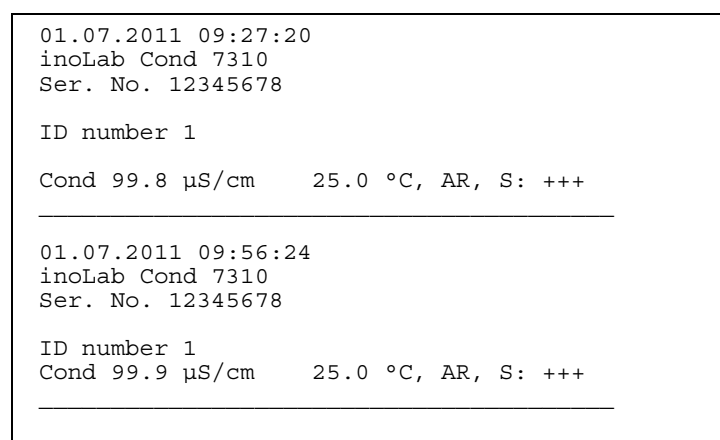

Quitting the display To quit the display of stored measurement datasets, you have the following options:

- Switch directly to the measured value display with **<M>**.
- Quit the display and move to the next higher menu level with **<F1>/[Back]**.

7.3.2 Erasing the measurement data storage

Erasing the measurement data storage (see section 7.3.1 DISPLAYING AND EDITING THE MEASUREMENT DATA STORAGE, page 38).

7.3.3 Measurement dataset

A complete dataset includes:

- ID number
- Date/time
- Measured value of the connected sensor
- Measured temperature value of the connected sensor
- AutoRead info: The AR indicator appears with the measured value if the AutoRead criterion was met while storing (stable measured value). Otherwise, there is no AR indicator.
- Calibration evaluation: +++, ++, +, -, or no evaluation

7.3.4 Storage locations

The Cond 7310 meter has two measurement data storages. The measured values recorded either manually or automatic are stored separately in individual measurement data storages.

Storage	Maximum number of datasets
<i>Manual data storage</i>	200
<i>Automatic data storage</i>	5000

8 Transmitting data (USB interface)

8.1 Options for data transmission

Via the USB interface you can transmit data to a PC. The following table shows which data are transmitted to the interface in which way:

Data	Control	Operation / description
Current measured values of all connected sensors	Manual	<ul style="list-style-type: none"> ● With <F2>/<i>[USB output]</i>. ● Simultaneously with every manual storage process (see section 7.1 MANUAL DATA STORAGE, page 35).
	Automatic, at intervals	<ul style="list-style-type: none"> ● With <F2__>/<i>[USB output]</i>. Then you can set the transmission interval. ● Simultaneously with every automatic storage process (see section 7.2 AUTOMATIC DATA STORAGE AT INTERVALS, page 36).
Stored measured values	Manual	<ul style="list-style-type: none"> ● Displayed dataset with <F2>/<i>[USB output]</i> after calling up from the storage. ● All datasets with the <i>Output to USB</i> function. <p>Details (see section 7.3.1 DISPLAYING AND EDITING THE MEASUREMENT DATA STORAGE, page 38).</p>
Calibration records	Manual	<ul style="list-style-type: none"> ● Displayed calibration record with <F2>/<i>[USB output]</i>. <p>Details (see section 5.2.4 CALIBRATION DATA, page 25).</p>
	Automatic	<ul style="list-style-type: none"> ● At the end of a calibration procedure.



The following rule applies: With the exception of the menus, shortly pressing the *[USB output]<F2>* key generally outputs the display contents to the interface (displayed measured values, measurement datasets, calibration records).

8.2 Connecting a PC

Connect the Cond 7310 to the PC via the USB interface.

NOTE

When connecting a grounded PC, measurements cannot be performed in grounded media as the values would be incorrect. The USB interface is not galvanically isolated.

Installation of the USB driver on the PC

System requirements of the PC for installation of the USB driver:

- PC with Pentium processor or higher with at least one free USB connection and CD-ROM drive
- Windows 2000, XP, Vista, 7.

1. Insert the supplied installation CD in the CD drive of your PC.
2. Install the driver from the CD.
Follow the Windows installation instructions as necessary.
3. Connect the Cond 7310 to the PC via the USB interface.
The meter is listed as a virtual COM interface among the connections in the Windows instrument manager.

8.3 MultiLab Importer

With the aid of the MultiLab Importer software, you can record and evaluate measurement data with a PC.



More detailed information can be found in the MultiLab Importer operating manual.

9 Printer (only Cond 7310 P)

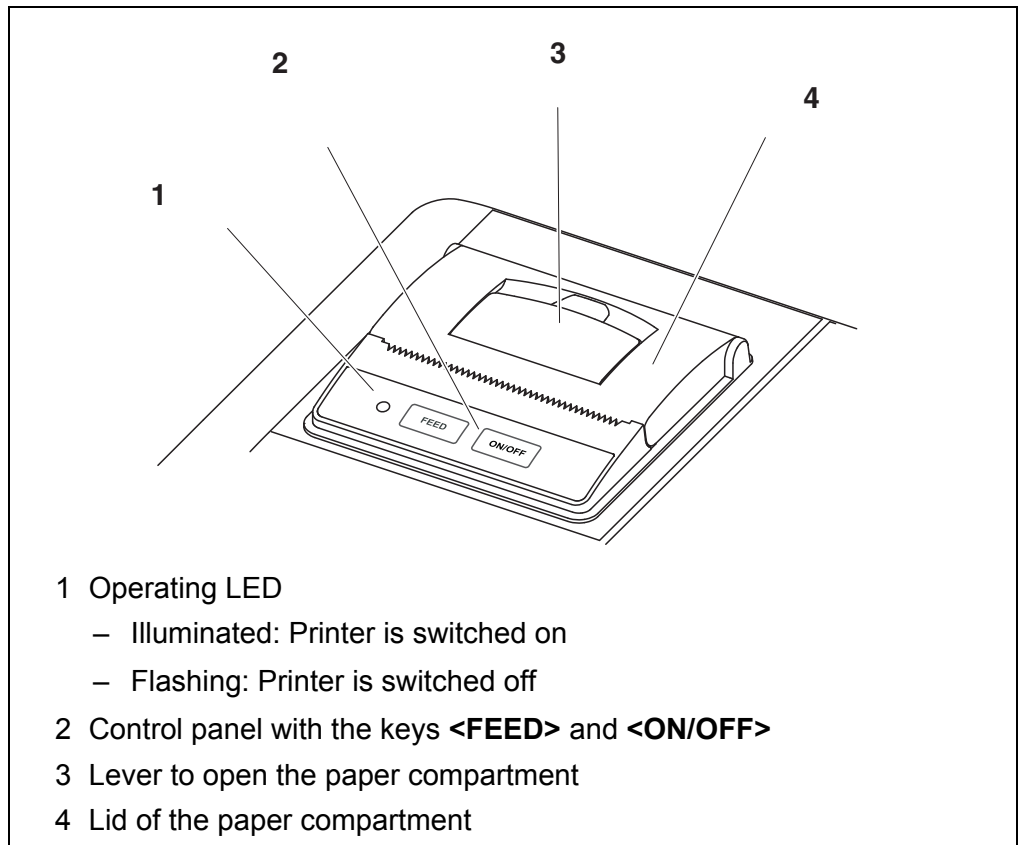

9.1 Commissioning / switching the printer on or off

Switching on the printer

1. Connect the power pack to the Cond 7310 P.
The LED lights up green. The printer is ready for operation.
or
If the printer was switched off (LED flashing):
Switch on the printer with <ON/OFF>.
The LED lights up green. The printer is ready for operation.



If there is a USB connection (such as to a PC) the data are output only to the PC.

Switching off the printer

1. Switch off the printer with <ON/OFF>.
The LED flashes. The printer is switched off.

9.2 Operation / printing

Data are only output to the printer if the following conditions are met

- Data are transmitted manually or automatically (see section 8.1 OPTIONS FOR DATA TRANSMISSION, page 41)
- the printer is switched on (LED illuminated)
- there is no USB connection.

9.3 Printer settings

To open the *Storage & config* menu, press the <F1_>[Menu] key in the measured value display. After completing the settings, switch to the measured value display with <M>.

Default settings are printed in **bold**.

Menu item	Possible setting	Description
<i>System / Printer / Font size</i>	12x20 8x16 7x16	Select the font size for the printer A print sample (character set of the printer) to view the available font sizes can be printed with <ON/OFF __>.
<i>System / Printer / Print test page</i>	-	The printer prints the meter information from the <i>System / Service information</i> menu. The current printer settings are used for the printout.

9.4 Maintenance

9.4.1 Changing the roll of paper

1. Pull the lever (3) upwards until the lid (4) of the paper compartment opens.
2. If necessary, remove any remains of the old roll of paper.
3. Insert the new roll of paper. The start of the paper should poke out of the paper compartment.
4. Close the lid (4) of the paper compartment so that it clicks into place.
5. If necessary, move the printer paper forward by one line with <FEED>.



Use original WTW rolls of paper only. You will find information on this in the WTW catalog LABORATORY AND FIELD INFORMATION or on the Internet.

The thermal paper will remain legible for at least 7 years if stored appropriately.

9.5 What to do if... / printer

Integrated printer does not print

Cause	Remedy
– Printer switched off (LED flashing)	– Switch on the printer (LED illuminated)
– No power pack connected	– Connect the power pack
– USB cable connected	– Disconnect the USB cable from the meter
– Function "automatic storing at intervals" with long intervals is switched on	– Switch off the function (see section 7.2 AUTOMATIC DATA STORAGE AT INTERVALS, page 36)
– No paper available	– Insert a roll of paper

Printer operating - paper not being printed

Cause	Remedy
– Paper inserted the wrong way up	– Turn the roll of paper around and insert it with the other side upwards

Integrated printer prints automatically

Cause	Remedy
– The function "Automatic storage at intervals" or "Transmit data automatic at intervals" is switched on	– Switch off the function (see section 7.2 AUTOMATIC DATA STORAGE AT INTERVALS, page 36 or section 8.1 OPTIONS FOR DATA TRANSMISSION, page 41)

10 Maintenance, cleaning, disposal

10.1 Maintenance

10.1.1 General maintenance activities

The only maintenance activity required is replacing the batteries.



See the relevant operating manuals of the measuring cells for instructions on maintenance.

10.1.2 Replacing the batteries



You can operate the meter either with normal batteries or with rechargeable batteries (Ni-MH). In order to charge the batteries, an external charging device is required.

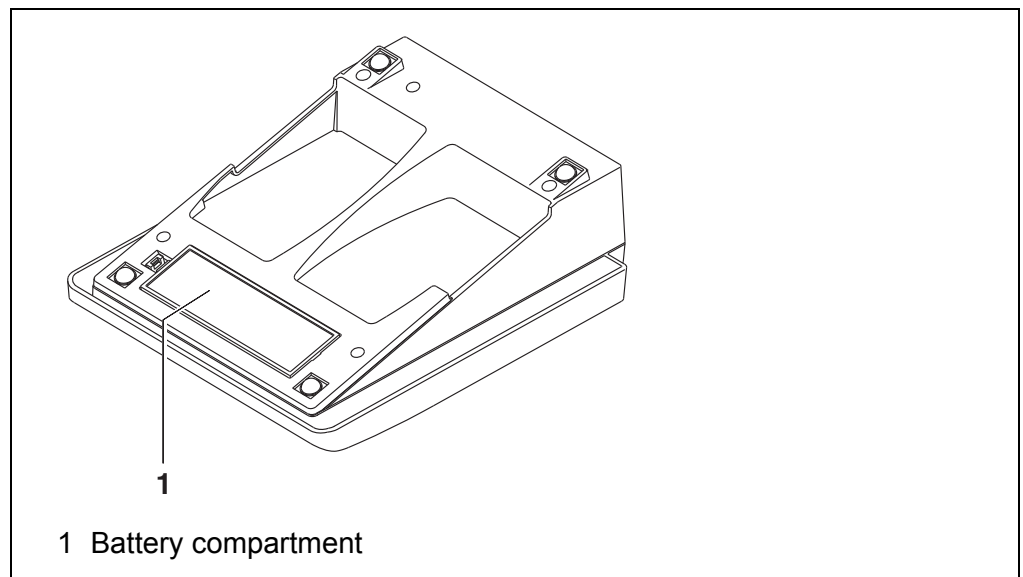

1. Open the battery compartment (1) on the underside of the meter.
2. Remove the four batteries from the battery compartment.
3. Place four new batteries (type Mignon AA) in the battery compartment.



CAUTION

Make sure that the poles of the batteries are positioned correctly.

The \pm signs on the batteries must correspond to the \pm signs in the battery compartment.

4. Close the battery compartment (1).

5. Set the date and time (see section 4.4.5 EXAMPLE 2 ON NAVIGATION: SETTING THE DATE AND TIME, page 20)



When the batteries are nearly empty, the  status indicator is displayed.



Dispose of used batteries according to the local regulations of your country.

End users within the European Union are obligated to return used batteries (even ecologically compatible ones) to a collection point set up for recycling purposes.

Batteries are marked with the crossed-out waste container symbol. Therefore, they may not be disposed with the domestic waste.

10.2 Cleaning

Occasionally wipe the outside of the measuring instrument with a damp, lint-free cloth. Disinfect the housing with isopropanol as required.



CAUTION

The housing is made of synthetic material (ABS). Thus, avoid contact with acetone or similar detergents that contain solvents. Remove any splashes immediately.

10.3 Packing

This meter is sent out in a protective transport packing.

We recommend: Keep the packing material. The original packing protects the meter against damage during transport.

10.4 Disposal

At the end of its operational lifetime, the meter must be returned to the disposal or return system statutory in your country. If you have any questions, please contact your supplier.

11 What to do if...

11.1 Conductivity



More information, as well as instructions on how to clean and exchange a sensor is given in the documentation of your sensor.

Error message *OFL, UFL*

The measured value is outside the measuring range.

Cause	Remedy
<ul style="list-style-type: none"> – The measured value is outside the measuring range of the meter 	<ul style="list-style-type: none"> – Use suitable measuring cell

Error message, *Error*

Cause	Remedy
<ul style="list-style-type: none"> – Measuring cell contaminated 	<ul style="list-style-type: none"> – Clean the cell and replace it if necessary
<ul style="list-style-type: none"> – Calibration solution not suitable 	<ul style="list-style-type: none"> – Check the calibration solutions
<ul style="list-style-type: none"> – Measuring cell not connected 	<ul style="list-style-type: none"> – Connect measuring cell

11.2 General information

Sensor symbol flashes

Cause	Remedy
<ul style="list-style-type: none"> – Calibration interval expired 	<ul style="list-style-type: none"> – Recalibrate the measuring system



Display

Cause	Remedy
<ul style="list-style-type: none"> – Batteries almost empty 	<ul style="list-style-type: none"> – Replace the batteries (see section 10.1 MAINTENANCE, page 46)

Meter does not react to keystroke

Cause	Remedy
<ul style="list-style-type: none"> – Operating condition undefined or EMC load unallowed 	<ul style="list-style-type: none"> – Processor reset: Press the <ENTER> and <On/Off> key simultaneously

**You want to know
which software
version is in the
meter**

Cause

- E. g., a question by the service department

Remedy

- Switch on the meter.
Open the menu, <F1_> /
[Menu] / *Storage & config* /
SystemService information.
The instrument data are displayed.

12 Technical data

12.1 Measuring ranges, resolution, accuracy

Measuring ranges, resolution

Parameter	Measuring range	Resolution
χ [μ S/cm]	0.000 ... 1.999*	0.001
	0.00 ... 19.99**	0.01
	0.0 ... 199.9	0.1
	200 ... 1999	1
χ [mS/cm]	2.00 ... 19.99	0.01
	20.0 ... 199.9	0.1
	200 ... 1000	1
ρ (Resistivity) [Ohm*cm]	1.000 ... 1.999	0.001
	2.00 ... 19.99	0.01
	20.0 ... 199.9	0.1
	200 ... 1999	1
ρ (Resistivity) [kOhm*cm]	2.00 ... 19.99	0.01
	20.0 ... 199.9	0.1
	200 ... 1999	1
ρ (Resistivity) [MOhm*cm]	2.00 ... 19.99**	0.01
	20.0 ... 199.9*	0.1
SAL	0.0 ... 70.0 according to the IOT table	0.1
TDS	0 ... 1999 mg/l	1
	2.00 ... 19.99 g/l	0.01
	20.0 ... 199.9 g/l	0.1
T [°C]	-5.0 ... +105.0	0.1
T [°F]	+23.0 ... +221.0	0.1

* only possible with cells of the cell constant, 0.010 cm^{-1}

** only possible with cells of the cell constant, 0.010 cm^{-1} or $0.090 \dots 0.110 \text{ cm}^{-1}$

Cell constants

Cell constant C	Values
Can be calibrated in the ranges	0.450 ... 0.500 cm ⁻¹ 0.800 ... 0.880 cm ⁻¹
Adjustable	0.090 ... 0.110 cm ⁻¹ 0.010 cm ⁻¹ (fixed) 0.250 ... 25.000 cm ⁻¹

Reference temperature

Reference temperature	Values
Adjustable	20 °C (Tref20) 25 °C (Tref25)

Accuracy (± 1 digit)

Parameter	Accuracy	Temperature of the test sample
x and ρ / temperature compensation		
None (Off)	± 0.5 %	
Nonlinear (nLF)	± 0.5 %	0 °C ... +35 °C according to EN 27 888
	± 0.5 %	+35 °C ... +50 °C enhanced nLF function
Linear (lin)	± 0.5 %	+10 °C ... +75 °C
SAL / range		
0.0 ... 42.0	± 0.1	+5 °C ... +25 °C
	± 0.2	+25 °C ... +30 °C
TDS [mg/l]		
	± 0.5 %	
T [°C] / temperature sensor		
NTC 30	± 0.1	
PT 1000	± 0.1	



The accuracy values specified here apply exclusively to the meter. The accuracy of the measuring cell has also to be taken into account.



More data are given in the documentation of your sensor.

12.2 General data

Dimensions	Cond 7310:	Approx. 230 x 190 x 80 mm
	Cond 7310 P:	Approx. 280 x 230 x 80 mm
Weight	Cond 7310:	Approx. 0.8 kg
	Cond 7310 P:	Approx. 1.0 kg
Mechanical structure	Type of protection	IP 43
Electrical safety	Protective class	III
Test certificates	CE	
Ambient conditions	Storage	-25 °C ... +65 °C
	Operation	+5 °C ... +55 °C With the power pack connected: +5 °C ... +40 °C
	Admissible relative humidity	Yearly mean: < 75 % 30 days/year: 95 % Other days: 85 %
Power supply	Batteries	4 x 1.5 V alkali-manganese batteries, type AA
	Rechargeable batteries	4 x 1.2 V NiMH rechargeable batteries, type AA (no charging function)
	Operational life	Up to 800 h without / 100 h with illumination
	Power pack	Kuantech Co. Ltd. KSAC 0900110W1UV-1 Input: 100 ... 240 V ~ / 50 ... 60 Hz / 270 mA Output: 9 V = / 1.1 A Connection max. overvoltage category II Primary plugs contained in the scope of delivery: Euro, US, UK and Australian.
USB interface	Type	USB 1.1 USB B (device), data output
	Baud rate	Adjustable: 1200, 2400, 4800, 9600, 19200 Baud
	Data bits	8
	Stop bits	2
	Parity	None
	Handshake	RTS/CTS
	Cable length	Max. 3 m
Applicable directives and standards	EMC	EC directive 2004/108/EC EN 61326-1 EN 61000-3-2 EN 61000-3-3 FCC Class A

Meter safety	EC directive 2006/95/EC EN 61010-1
IP protection class	EN 60529

FCC Class A Equipment Statement

Note: This equipment has been tested and found to comply with the limits for a Class A digital device, pursuant to Part 15 of the FCC Rules. These limits are designed to provide reasonable protection against harmful interference when the equipment is operated in a commercial environment. This equipment generates, uses, and can radiate radio frequency energy and, if not installed and used in accordance with the instruction manual, may cause harmful interference to radio communications. Operation of this equipment in a residential area is likely to cause harmful interference in which case the user will be required to correct the interference at his own expense.

Changes or modifications not expressly approved by the manufacturer could void the user's authority to operate the equipment.

13 Firmware update

Available firmware updates are provided on the Internet.

With the firmware update program and a PC you can update the firmware of the Cond 7310 to the newest version.

For the update you have to connect the meter to a PC.

For the update via the USB interface, the following is required:

- a free USB interface (virtual COM port) on the PC
- the driver for the USB interface (on the enclosed CD-ROM)
- the USB cable (included in the scope of delivery of the Cond 7310).

1. Install the downloaded firmware update on a PC.
An update folder is created in the Windows start menu.
If an update folder already exists for the meter (or meter type), the new data is displayed there.
2. In the windows start menu, open the update folder and start the firmware update program.
3. Using the USB interface cable, connect the Cond 7310 to a USB interface (virtual COM port) of the PC.
4. Switch on the Cond 7310.
5. In the firmware update program, start the update process with OK.
6. Follow the instructions of the firmware update program.
During the programming process, a corresponding message and a progress bar (in %) are displayed.
The programming process takes approx. three minutes. A terminatory message is displayed after a successful programming process. The firmware update is completed.
7. Disconnect the Cond 7310 from the PC.
The Cond 7310 is ready for operation again.

After switching the meter off and on you can check whether the meter has taken over the new software version (see YOU WANT TO KNOW WHICH SOFTWARE VERSION IS IN THE METER, PAGE 49).

14 Glossary

Conductivity

Cell constant C	Characteristic quantity of a conductivity measuring cell, depending on the geometry.
Conductivity	Short form of the expression, specific electrical conductivity. It corresponds to the reciprocal value of the resistivity. It is a measured value of the ability of a substance to conduct an electric current. In water analysis, the electrical conductivity is a dimension for the ionized substances in a solution.
Reference temperature	Fixed temperature value to compare temperature-dependent measured values. For conductivity measurements, the measured value is converted to a conductivity value at a reference temperature of 20 °C or 25 °C.
Resistance	Short name for the electrolytic resistivity. It corresponds to the reciprocal value of the electrical conductivity.
Salinity	The absolute salinity S_A of seawater corresponds to the relationship of the mass of dissolved salts to the mass of the solution (in g/Kg). In practice, this dimension cannot be measured directly. Therefore, the practical salinity according to IOT is used for oceanographic monitoring. It is determined by measuring the electrical conductivity.
Salt content	General designation for the quantity of salt dissolved in water.
Temperature coefficient	Value of the slope α of a linear temperature function. $\mathcal{R}_{T_{\text{Ref}}} = \mathcal{R}_{\text{Meas}} * \frac{1}{1 + \alpha * (T - T_{\text{Ref}})}$
Temperature compensation	Name of a function that considers the temperature influence on the measurement and converts it accordingly. Depending on the measured parameter to be determined, the temperature compensation functions in different ways. For conductimetric measurements, the measured value is converted to a defined reference temperature. For potentiometric measurements, the slope value is adjusted to the temperature of the test sample but the measured value is not converted.

General information

Adjusting	To manipulate a measuring system so that the relevant value (e. g. the displayed value) differs as little as possible from the correct value or a value that is regarded as correct, or that the difference remains within the tolerance.
AutoRange	Name of the automatic selection of the measuring range.
Calibration	Comparing the value from a measuring system (e. g. the displayed value) to the correct value or a value that is regarded as correct. Often, this expression is also used when the measuring system is adjusted at the same time (see adjusting).

Measured parameter	The measured parameter is the physical dimension determined by measuring, e. g. pH, conductivity or D.O. concentration.
Measured value	The measured value is the special value of a measured parameter to be determined. It is given as a combination of the numerical value and unit (e. g. 3 m; 0.5 s; 5.2 A; 373.15 K).
Molality	Molality is the quantity (in Mol) of a dissolved substance in 1000 g solvent.
Reset	Restoring the original condition of all settings of a measuring system.
Resolution	Smallest difference between two measured values that can be displayed by a meter.
Stability control (AutoRead)	Function to control the measured value stability.
Standard solution	The standard solution is a solution where the measured value is known by definition. It is used to calibrate a measuring system.
Temperature function	Name of a mathematical function expressing the temperature behavior of a test sample, a sensor or part of a sensor.
Test sample	Designation of the test sample ready to be measured. Normally, a test sample is made by processing the original sample. The test sample and original sample are identical if the test sample was not processed.

15 Index

A

Automatic switch-off 16
AutoRead 23

B

Battery compartment 11, 46

C

Calibration evaluation 26
Calibration interval 30
Connecting a PC 42
Control standard 25
Copyright 2

D

Dataset 40
Date and time 20
Default settings
 Measured parameter 33
 System settings 34
Display 15

E

Energy saving mode 37

F

Firmware update 54

I

Initial commissioning 10
Initialize 33
Interval for calibration 30

K

Keys 13

M

Measured value display 17
Measurement accuracy 30
Measurement data storage
 Edit 38
 Erase 38
 Storage locations 40
Measurement dataset 40
Measuring 22
Menus (navigation) 17
Messages 18

P

Print 41
Printer (only Cond 7310P) 43

R

Reset 33

S

Scope of delivery 10
Socket field 15
Storage interval 36
Storing in memory 35
 At intervals 36
 Automatic 36
 Manual 35

T

TDS factor 31
Temperature compensation 31
Transmitting data 41
 Automatic 41
 Manual 41
Transmitting measured values 41

Xylem |'zīləm|

- 1) The tissue in plants that brings water upward from the roots;
- 2) a leading global water technology company.

We're a global team unified in a common purpose: creating advanced technology solutions to the world's water challenges. Developing new technologies that will improve the way water is used, conserved, and re-used in the future is central to our work. Our products and services move, treat, analyze, monitor and return water to the environment, in public utility, industrial, residential and commercial building services settings. Xylem also provides a leading portfolio of smart metering, network technologies and advanced analytics solutions for water, electric and gas utilities. In more than 150 countries, we have strong, long-standing relationships with customers who know us for our powerful combination of leading product brands and applications expertise with a strong focus on developing comprehensive, sustainable solutions.

For more information on how Xylem can help you, go to www.xylem.com.



Service and Returns:

Xylem Analytics Germany
Sales GmbH & Co. KG
WTW
Am Achalaich 11
82362 Weilheim
Germany

Tel.: +49 881 183-325
Fax: +49 881 183-414
E-Mail wtw.rma@xylem.com
Internet: www.xylemanalytics.com



Xylem Analytics Germany GmbH
Am Achalaich 11
82362 Weilheim
Germany

